

NIMH - TECHNICAL DATA SHEET - MODEL ESP2200SCHR

TECHNICAL DATA SHEET

Battery General Specification :

- Model** - ESP2200SCHR
Chemical Material - Nickel Metal Hydride.
Description - 1.2v Rechargeable battery
 4/5 SUB C size.
 High Rate Type.

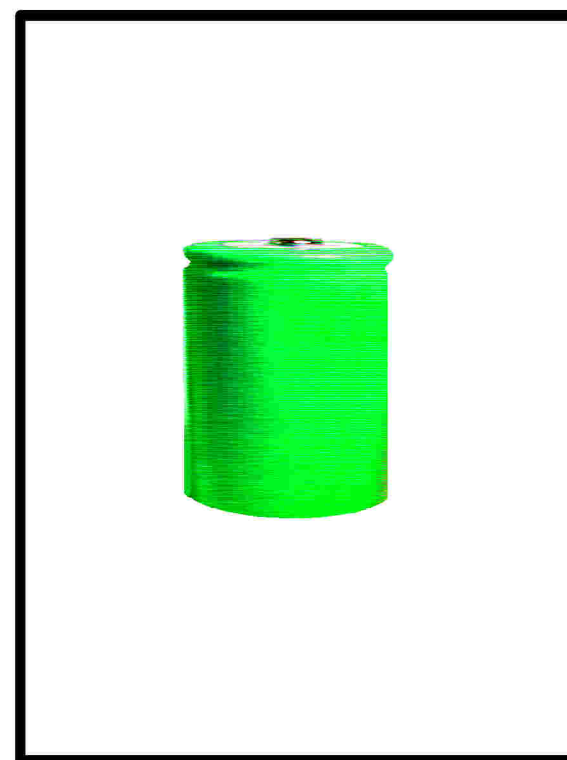

型号(Type) : HP34SC2200P

单颗电池规格 Specifications of single cell

标称电压 Nominal voltage		1.2V	
容量 Capacity		0.2C 放电 Discharge	10C 放电 Discharge
	最小 Minimum 典型 Typical	275min 300min	5.0min 5.7min
尺寸 Dimensions		mm	
	直径 Diameter 高 Height	22.5 ^{-0.7} 34.0 ^{-1.0}	
大约重量 Weight(Approximately)		克 gram 50.0	
电阻 Internal Impedance At 1000 Hz		8mΩ(Max) (充电后 After Charge)	
充电 Charge	标准 Standard	220mA(0.1C)×15hrs	
	快 速 Rapid	2200mA(1.0C)×1.5hrs	
环境温度 Ambient temperature	充电 Charge	标准 standard	0℃ to 45℃
		快速 Rapid	0℃ to 40℃
	放电 Discharge 贮藏 Storage	-20℃ to 50℃ -20℃ to 40℃	

单颗电池尺寸包括 PVC (Dimensions with tube)

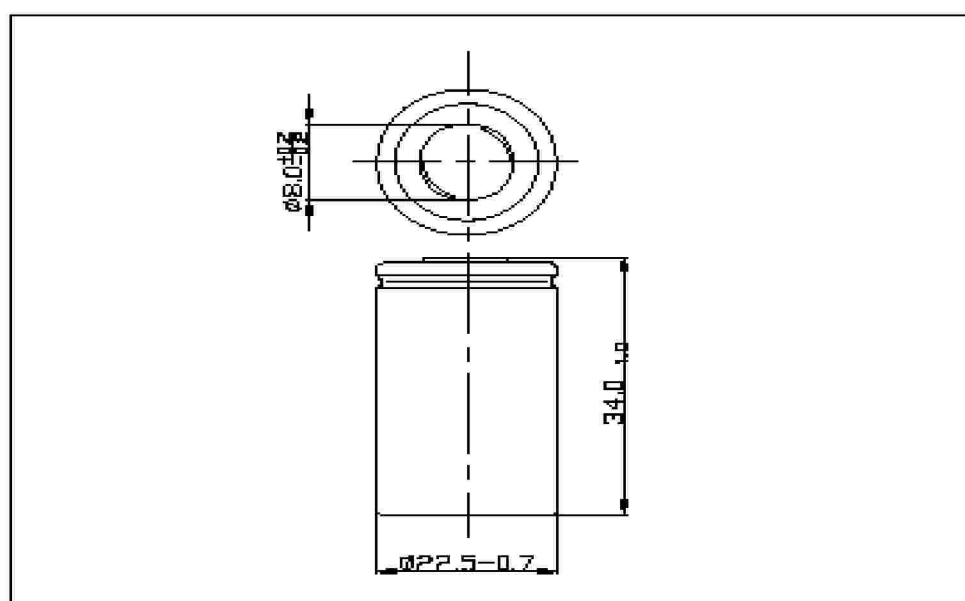

备注 Note:

- 标称容量是指 20℃ 时 0.2C 放电容量
Nominal capacity, rated at 0.2C 20℃.
- 容量只作为参考
Average capacity, for reference only.
- 重量和内阻也作为参考
Weight and internal impedance are For reference.
- 寿命测试依照 IEC 标准
Standard according as IEC of test cycle life.

制造商保留在没有预先通知的情况下改变和修正设计及规格说明书的权力

Manufacturer reserve the right to alter or amend the design, model and specification without prior notice

CELLS MANUFACTURED TO GB/T19001:2000 - ISO9000/9001: 2000 STANDARD & CONFORMITY
Cell & Battery specifications are subject to modifications without prior notice. All the above information is generally discriptive and is not intended as a guarantee or warranty.

ESP SPECIAL BATTERIES LTD
 21A Spencefield Lane, 565 Uppingham Rd
 Leicester. LE5 6PT Leicester. LE5 6QA
 England. England.

Tel 0116 2413796
 Fax 0116 2416519
 Email - info@espspecialbatteries.co.uk
www.espspecialbatteries.co.uk

典型特征 Typical characteristics

标准充电特征 Standard charge

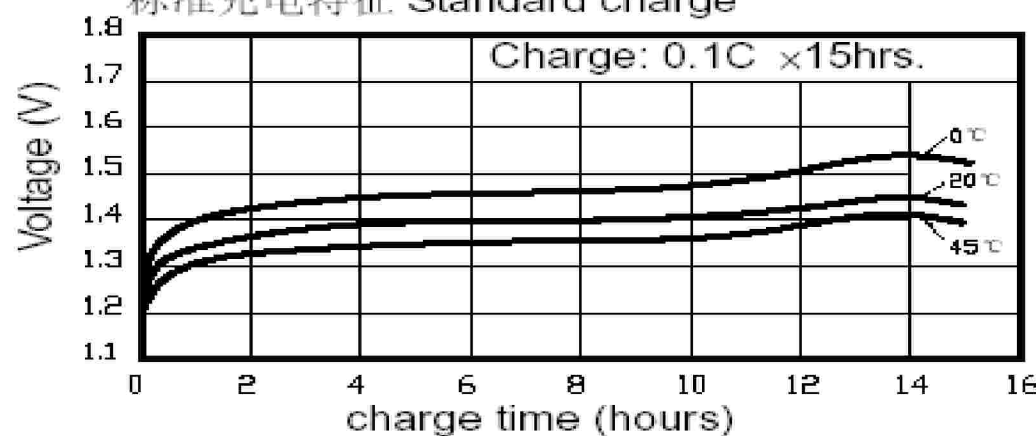

快速充电特征 Rapid charge

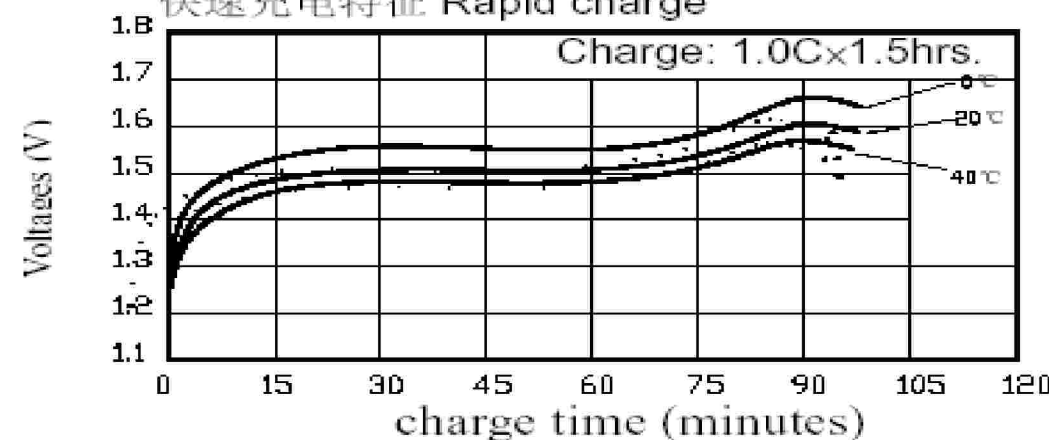

放电特征 Discharge characteristics

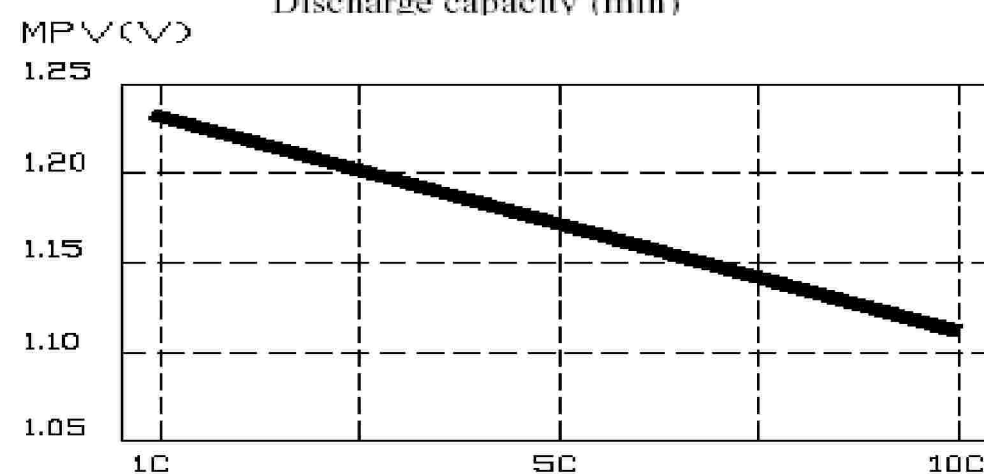
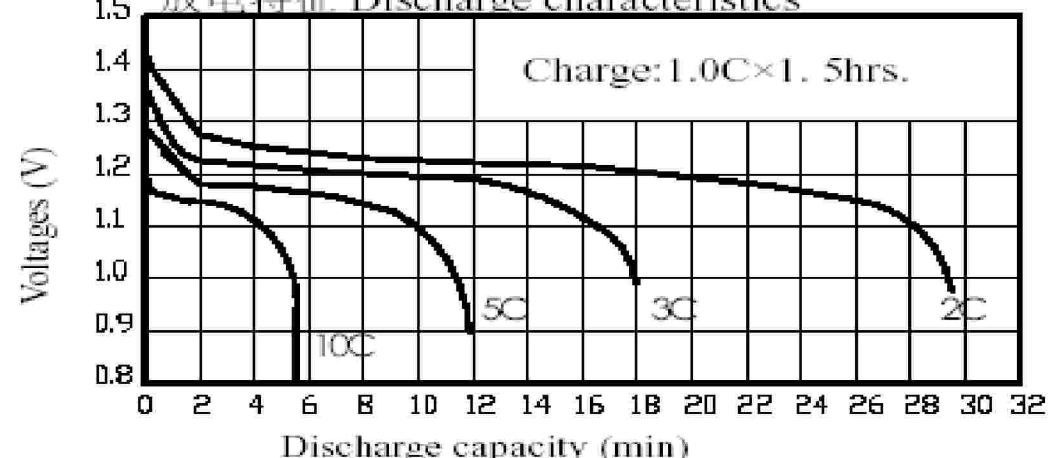

Ni-MH 圆柱型电池在不同的温度荷电保持曲线图
 Charge retention curves of Ni-MH cylindrical cell At various storage temperature

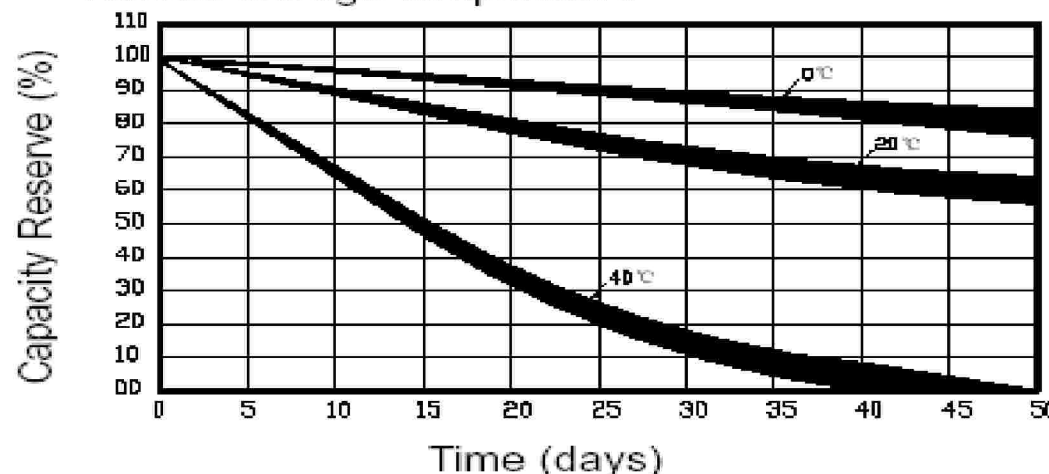

ESP2200SCHR